

Linear 024
Vertical System Hanging

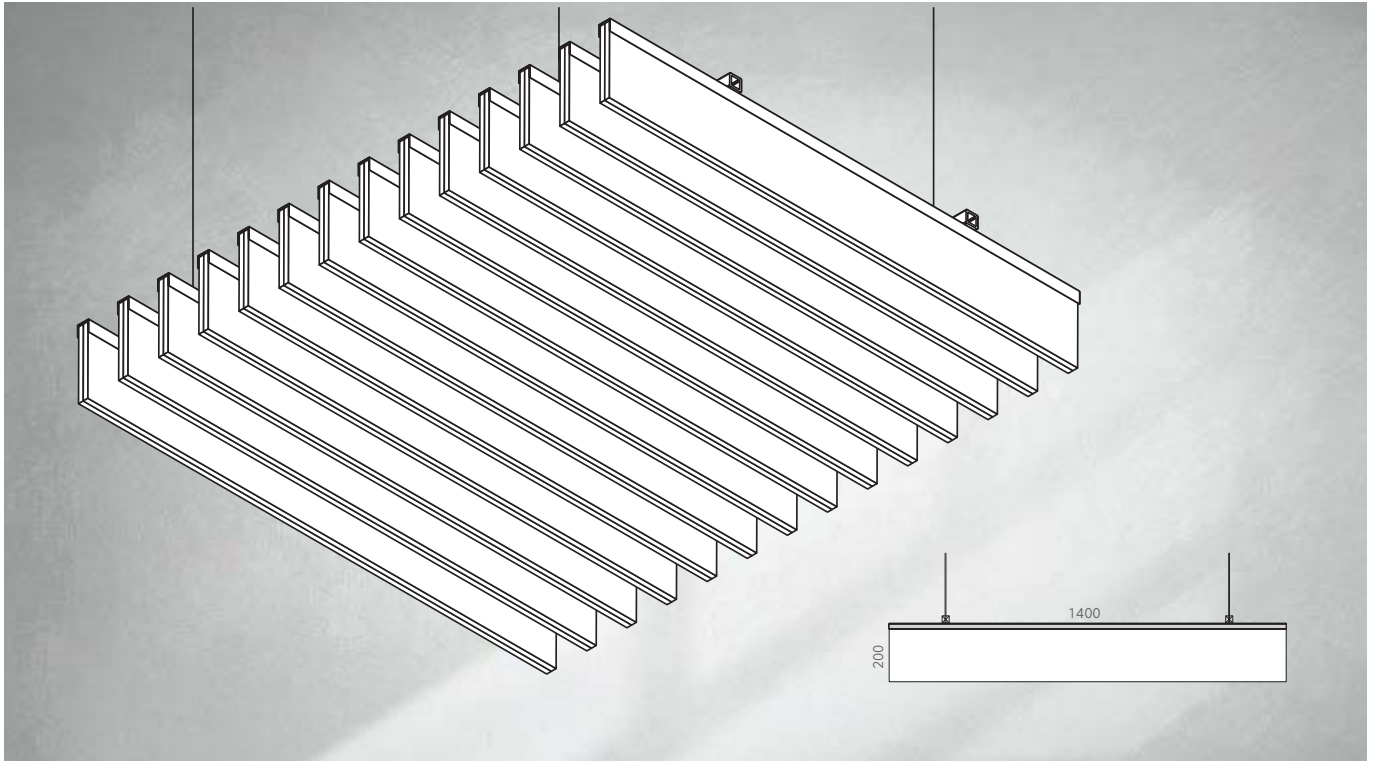

Product Name Ceiling Baffle-Linear 024
 Product Category Ceiling
 Material 100% Polyester fibers with > 60% recycled content
 Weight 4,800 gram/ sq.m +/-
 Density 200 kgs/Cubic.m +/-
 Thickness 24 mm +/-10%
 Size 200 mm x 1,400 mm

Performance
 Sound Transmission Class STC 5, ISO 717 Part 1
 Sound Absorption NRC 0.60 with no air gap, ISO 354

Sound Absorption Coefficients(as)

(Hz)	125	250	500	1000	2000	4000
Frequency f	0.00	0.74	0.31	0.61	0.80	0.91

Color Fastness to Light > 6, ISO 105 B02-1994
 Indoor Air Quality Low VOCs emission, formaldehyde and Phenol-free
 Moisture Content < 0.10% by weight

Available Colors



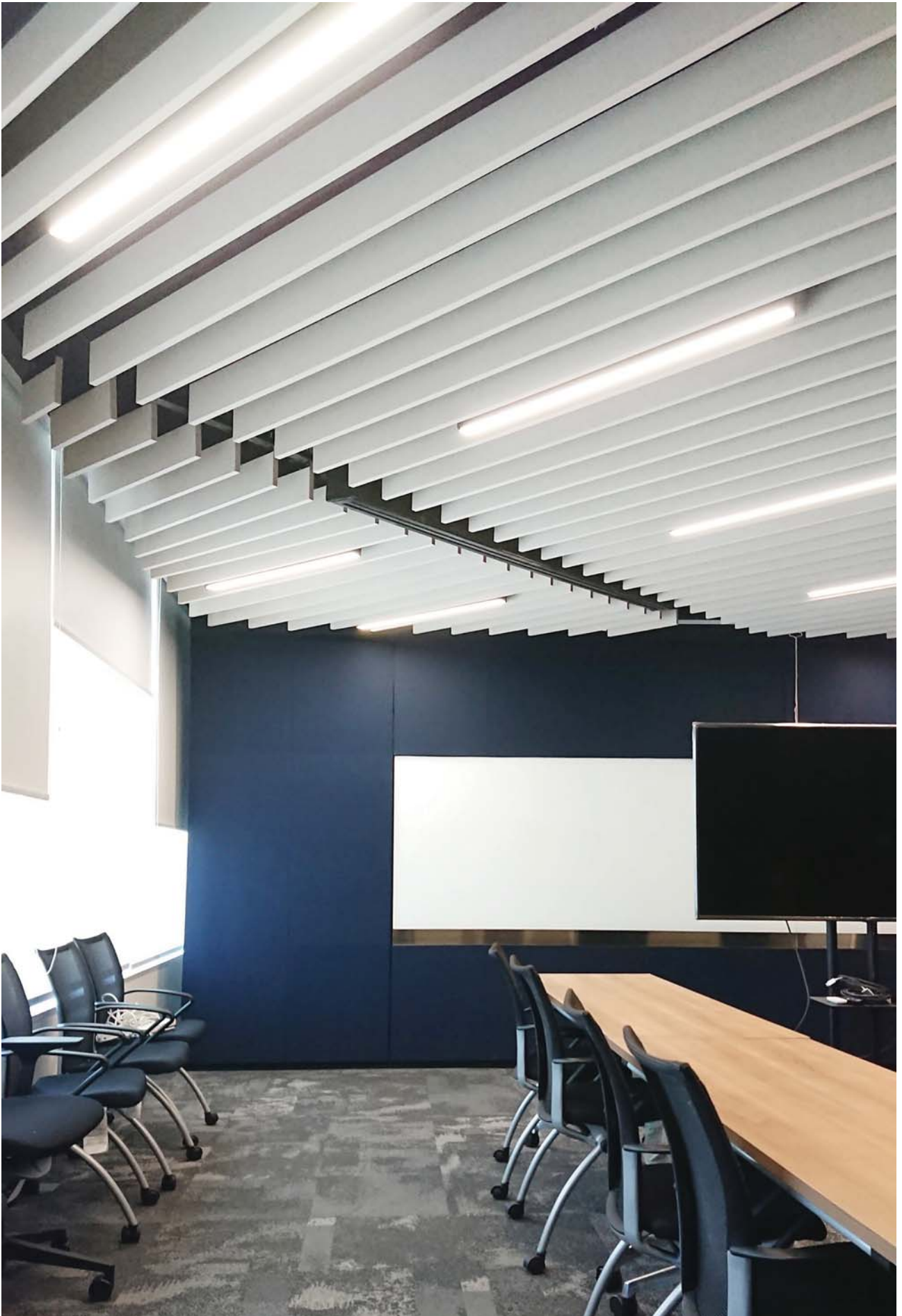

Fittings :

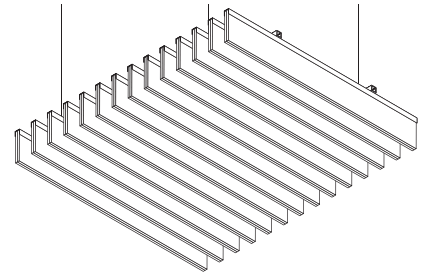
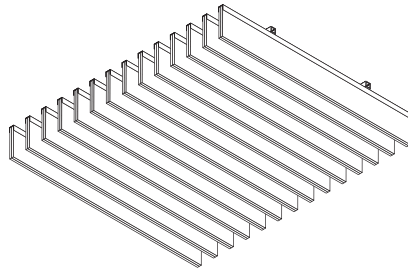

Suspension Hanging :

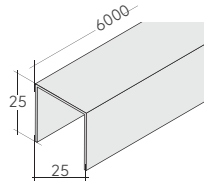

AC 018, U-channel,
1x1", length 6m
Color, Aluminum / Mate black

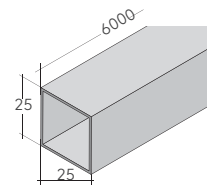

Square tube 1x1"
Length 6 m

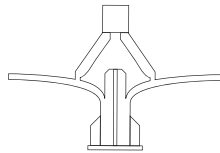

Wing toggle plug



Steel Threaded Rod
1/4, Length 1 m

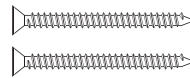

Screw F8(M4) 1 - 1 1/2"



Double Expansion
Anchor 1/4"



Metal Screw
#6 3/4



Metal Screw
#6 3/4



Screw F8(M4) 3/4"

Shape option :

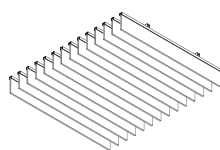

Linear Shape

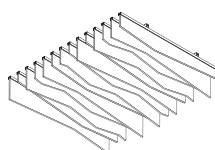

Blade Shape

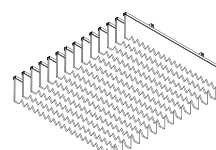

Saw Blade Shape

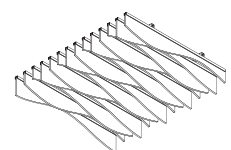

Wing Shape