

Ceiling Beam Baffle 1250 Vertical System Hanging

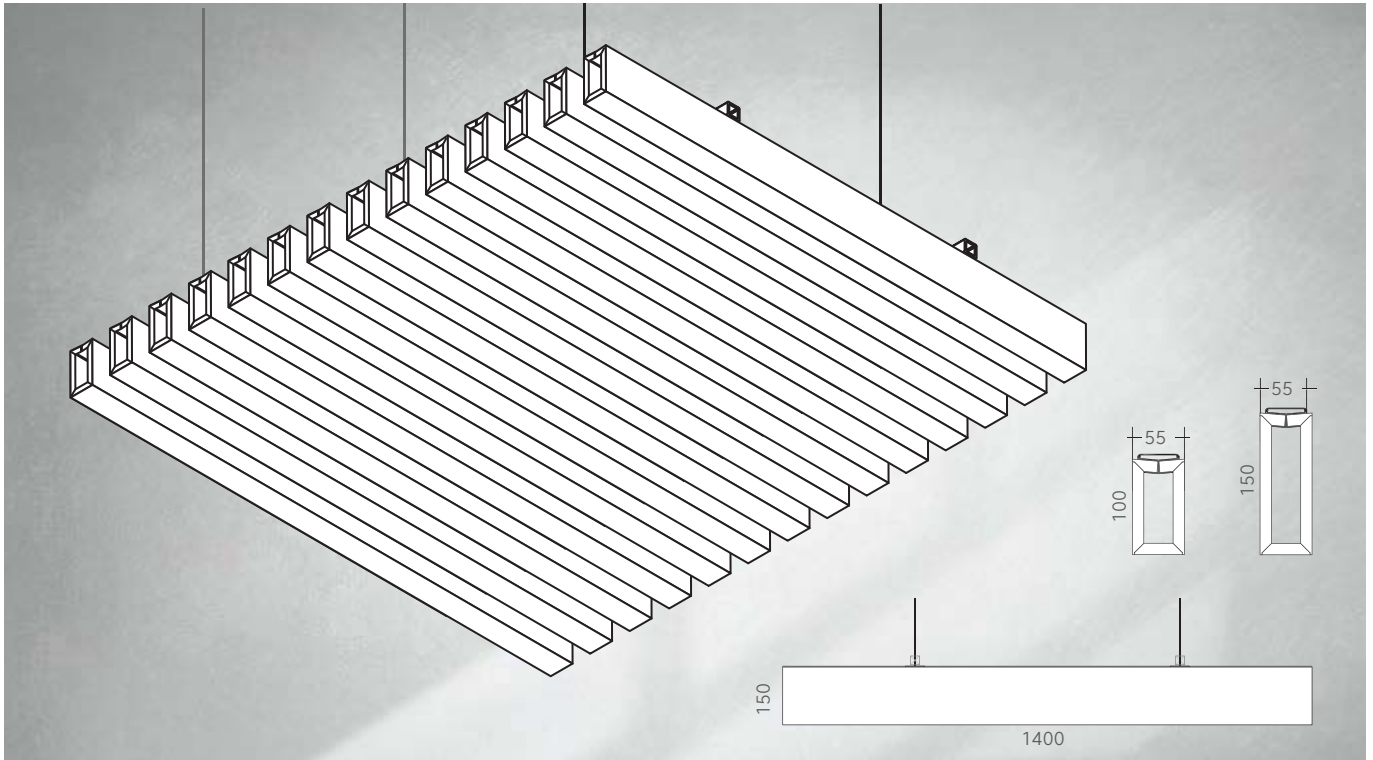

Product Name	Ceiling Beam Baffle-1255
Product Category	Ceiling
Material	100% Polyester fibers with > 60% recycled content
Weight	1,655 gram / pc +/-
Density	200 kgs/Cubic.m +/-
Thickness	50 mm +/-10%
Dimension	1,400 mm x 1,400 mm x 150 mm

Performance	
Sound Transmission Class	STC 5, ISO 717 Part 1
Sound Absorption	NRC 0.75 with air gap, ISO 354
Color Fastness to Light	> 6, ISO 105 B02-1994
Reaction to Fire	EN 13501-1, Class B-s1, d0
Indoor Air Quality	Low VOCs emission, formaldehyde and Phenol-free
Moisture Content	< 0.10% by weight

Available Colors





Fittings :

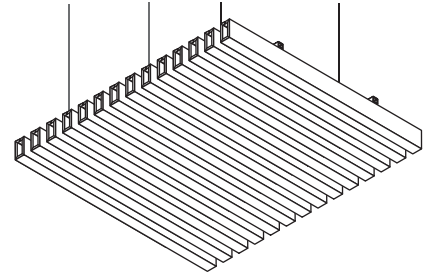
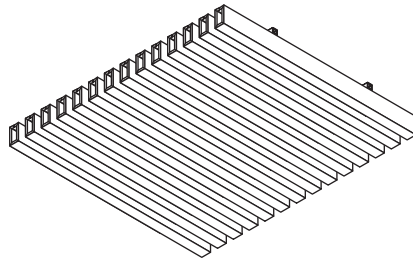

Suspension Hanging :

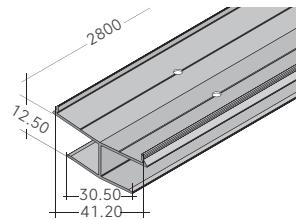

AC-028, for AP12 Beam Baffles
Length 2.80m, Aluminum alloy

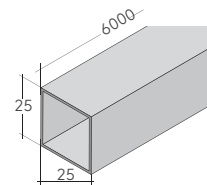

Square tube 1x1"
Length 6 m

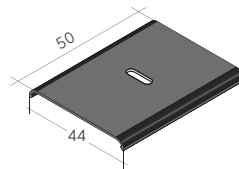

AC-028, Bracket for AC-029,
Aluminum alloy



Steel Threaded Rod
1/4, Length 1 m

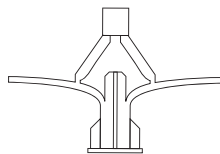

Wing toggle plug



Double Expansion
Anchor 1/4"

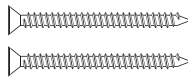

Screw F8(M4) 1 - 1 1/2"



Metal Screw
#6 3/4

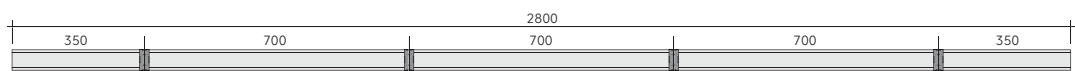
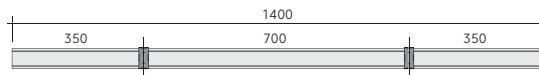

Installation :

